



Content

1. Introduction
2. Impact of the solid surface
 - Surface properties
 - Consistency of surface properties
3. Performance of Greiner Bio-One high binding microplates
 - Exemplary ELISAs
 - Binding of biotinylated proteins
4. Microplate format and well profile
5. Technical Appendix
6. Ordering Information

Microplates for Enzyme Linked Immunosorbent Assays (ELISA)

1. Introduction

ELISA (**E**nzyme **L**inked **I**mmunosorbent **A**ssay) is one of the most widely used biochemical method in laboratory analysis and diagnostics. Analytes such as peptides, proteins, antibodies and hormones can be detected selectively and quantified in low concentrations among a multitude of other substances. Additionally, ELISAs are rapid, sensitive, cost effective and can be performed in a high-throughput manner. An ELISA is used in a vast variety of different types of assays (e.g. direct ELISA, indirect ELISA, sandwich ELISA, competitive ELISA, see technical appendix). Nevertheless, all ELISA variants are based on the same principle, the binding of one assay component – antigen or specific antibody – to a solid surface and the selective interaction between both assay components. Molecules not specifically interacting with the assay component bound to the solid surface are washed away during the assay. For the detection of the interaction the antibody or antigen is labelled or linked to an enzyme (direct ELISA). Alternatively, a secondary antibody conjugate can be used (indirect ELISA). The assay is developed by adding an enzymatic substrate to produce a measurable signal (colorimetric, fluorescent or luminescent). The strength of the signal indicates the quantity of analytes in the sample.

2. Impact of the solid surface

A key step in an ELISA is the binding of one assay component – antigen or antibody – to the solid surface. Therefore, the features of this surface, most often the wells of a 96 well microplate, are crucial for the performance of the assay.

2.1. Surface properties

The attachment of antigens or antibodies to a solid surface, also referred to as coating, is based upon passive adsorption. Therefore physicochemical forces like hydrophobic bonds and H-bonding are relevant. Hydrophobic bonds are based on close interactions between hydrophobic groups. Molecules containing hydrophilic groups can be bound by hydrophilic interactions if hydrophilic groups are present on the solid surface. Bonds based upon passive adsorption are generally not that strong and their nature is transient. Binding depends on many factors like size and properties of the molecule to be bound, pH of the coating buffer and temperature. Nevertheless, once the interactions between the solid surface and the molecules are established in large numbers, the binding is very stable.

Polystyrene is the most widely used material for immunological microplates. The resin is highly transparent and ideally suited for optical measurements. Due to its chemical nature polystyrene is a hydrophobic compound and non-treated polystyrene plates feature hydrophobic characteristics. As for most ELISA applications the presence of hydrophilic groups at the surface is beneficial, ELISA plates are most often physically treated to introduce a defined number of hydrophilic groups to the plate surface. Non-treated polystyrene microplate surfaces contain about 0.5 atom% oxygen, whereas the oxygen content of Greiner Bio-One high binding microplates is approximately 2.5 atom% (Fig. 1).

2.2. Consistency of surface properties

Microplates used for immunological assays must feature defined and consistent binding characteristics.

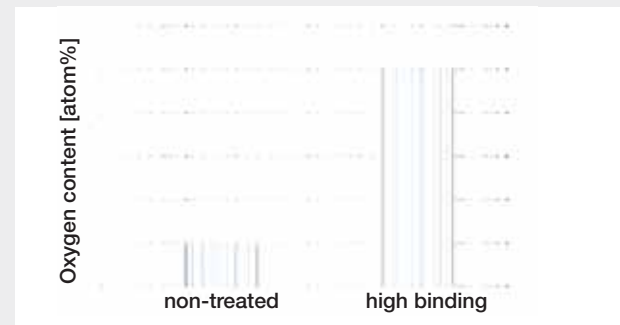

Figure 1: Oxygen content on polystyrene microplate surfaces determined by XPS (X-ray photoelectron spectroscopy).

Key features besides the physical surface treatment are the usage of high-quality virgin polystyrene and a well-established and monitored manufacturing process.

At Greiner Bio-One incoming raw material lots are quality tested in a sample production and a subsequent immunoassay. The new raw material lot is only accepted for production if the sample plates fulfill the following criteria:

- For intra-plate homogeneity the coefficient of variation (CV) must not exceed 5% for colorimetric or 10% for fluorescence and luminescence assays.
- For all immunological products, to guarantee constant binding properties, the CV for five tested plates must not exceed 10%. Additionally, the ratio of new sample plates to reference plates has to be in the range of 100 +/- 10%.

The CV is a measure of the variation of the optical density values in different wells. It is a benchmark for the homogeneity of a surface with regard to binding properties. The lower the CV the more consistent are the binding properties of the tested surfaces. The CV is calculated according to the following formula:

$$CV [\%] = \frac{\text{standard deviation}}{\text{mean}} \cdot 100\%$$

Fig. 2A-C and 3A-C show the CVs and optical density values of samples of three different microplate formats taken randomly from ten production lots over four

years. The microplates were tested with two ELISA protocols: a) a direct ELISA where human IgG, a 150 kDa glycoprotein, is bound to the plate surface and b) an indirect ELISA where the plates were coated with the 5.8 kDa peptide hormone insulin. With both assays CVs for all tested plates were well below the staked 5% limit and in each experimental set up the ratio of the measured optical densities was within the given 10% tolerance (Table 1).

Cat.-No.	Description	IgG	Insulin
655 061	F-bottom/ standard 96 well microplates	94.3%	98.8%
705 071	C8 Single break strip plates	92.8%	91.9%
762 071	F8 Strip plates	92.3%	93.8%

Table 1: Maximum ratio within the tested plates

Direct ELISA Detection of Human IgG (150 kDa)

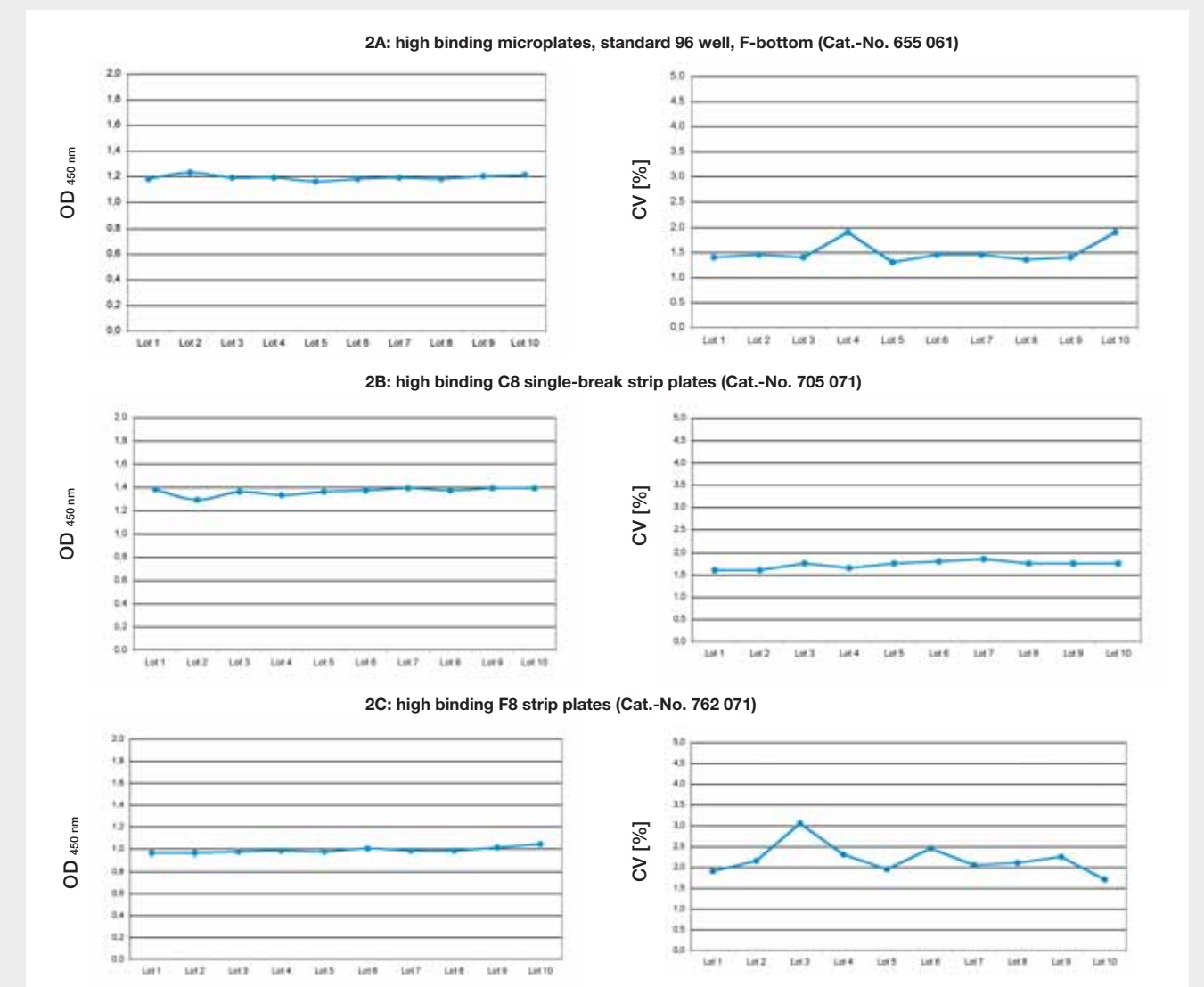
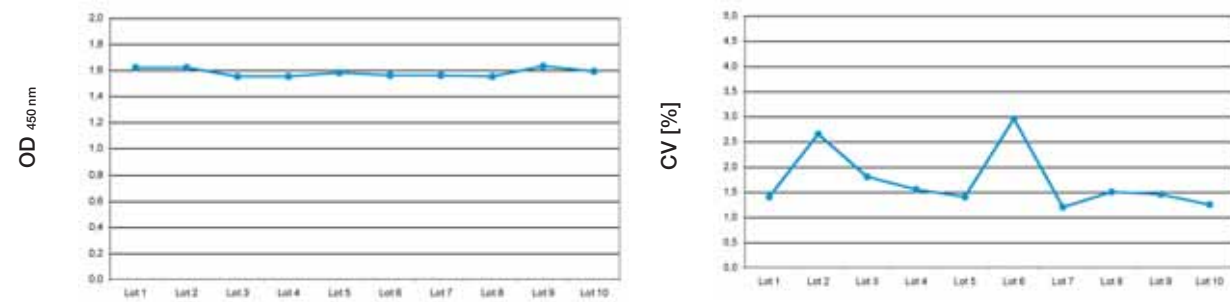

Figure 2A-C: Optical density values and coefficients of variation of different formats of Greiner Bio-One ELISA microplates. Human IgG was bound to the plate surface (5 µg/ml) and detected colorimetrically with a goat anti-human IgG-HRP conjugate (3.3 ng/ml) and TMB. Figure 2A: 655 061 (high binding F-bottom / standard 96 well microplates); Figure 2B: 705 071 (high binding C8 Single-break strip plates); Figure 2C: 762 071 (high binding F8 strip plates).

Indirect ELISA Detection of Insulin (5,8 kDa)

3A: high binding microplates, standard 96 well, F-bottom (Cat.-No. 655 061)



3B: high binding C8 single-break strip plates (Cat.-No. 705 071)

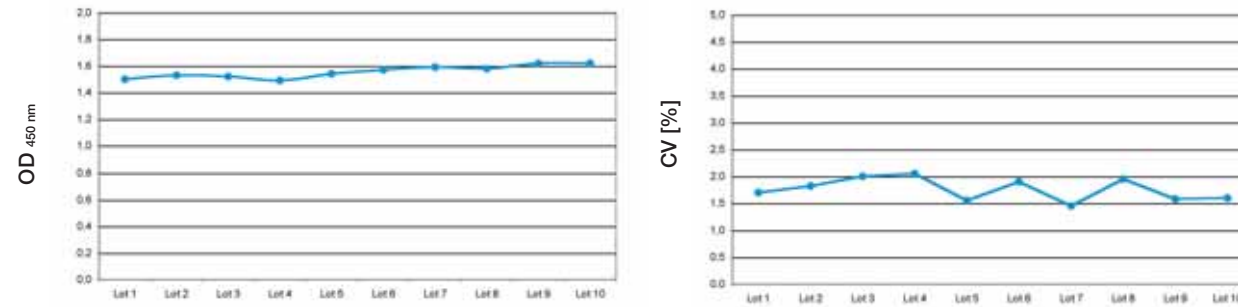

3C: high binding F8 strip plates (Cat.-No. 762 071)

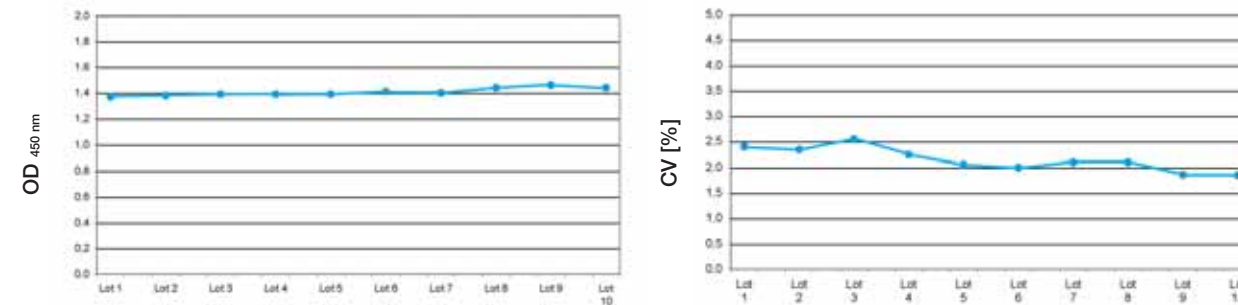

Figure 3A-C: Optical density values and coefficients of variation of different formats of Greiner Bio-One ELISA microplates. The microplate surface was coated with the peptide hormone insulin (800 ng/ml). A monoclonal anti-insulin antibody (mouse, 80 ng/ml) in combination with an anti-mouse IgG-HRP conjugate (300 ng/ml) was used for colorimetric detection with TMB in an indirect ELISA. **Figure 3A:** 655 061 (high binding F-bottom /standard 96 well microplates); **Figure 3B:** 705 071 (high binding C8 Single-break strip plates); **Figure 3C:** 762 071 (high binding F8 strip plates).

3. Performance of Greiner Bio-One high binding microplates

3.1 Exemplary ELISAs

A set of different immunoassays (direct and indirect ELISAs) was established in our laboratory on high binding microplates. Working concentrations were determined by performing checkerboard titrations. The working concentrations used are shown in **Table 2**.

- The 150 kDa glycoprotein IgG (human) was bound to the microplate surface and detected with a goat anti-human IgG-horseradish peroxidase (HRP) conjugate in a direct ELISA.
- Binding of the peptide hormone insulin (5.8 kDa, 51 AA) was detected with a monoclonal mouse anti-insulin antibody (AB) and an anti-mouse IgG-HRP conjugate in an indirect ELISA.

- Microplates were coated with high-density lipoproteins (HDL). HDL forms a class of lipoproteins that carry fatty acids and cholesterol in the blood from the body's tissues to the liver. HDL has a hydrophobic core. Binding of HDL was detected with an anti-HDL antibody from goat and an anti-goat IgG-HRP conjugate in an indirect ELISA.
- The binding of the glycoprotein hormone erythropoietin (EPO) to the plate surface was detected in an indirect ELISA with an anti-EPO antibody from rabbit and an anti-rabbit IgG-HRP conjugate. EPO regulates the red blood cell production. It is an acidic 34 kDa polypeptide consisting of 165 amino acid residues. Carbohydrate side chains account for approx. 40% of the molecular mass of EPO.

Conclusion:

Greiner Bio-One high binding microplates demonstrated excellent performance in all tested immunoassays. Reproducible protocols with coefficients of variation less than 3% were established for all assays (**Fig. 5**).

Molecule	Coating concentration	Primary antibody	Secondary antibody
IgG	5 µg/ml	3.3 ng/ml	/
Insulin	800 ng/ml	80 ng/ml	300 ng/ml
HDL	800 ng/ml	300 ng/ml	1,25 µg/ml
EPO	400 µg/ml	600 ng/ml	300 ng/ml

Table 2: Ratio of the measured optical density

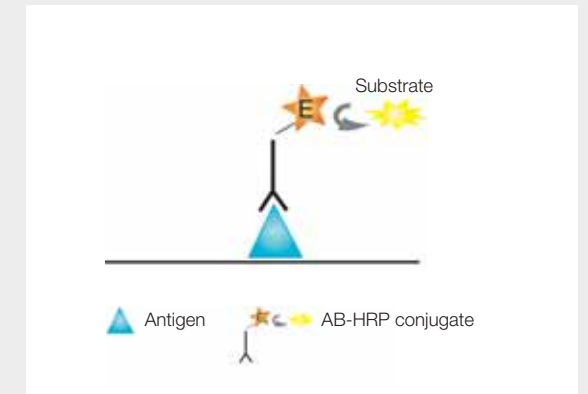

Figure 4A: Direct ELISA

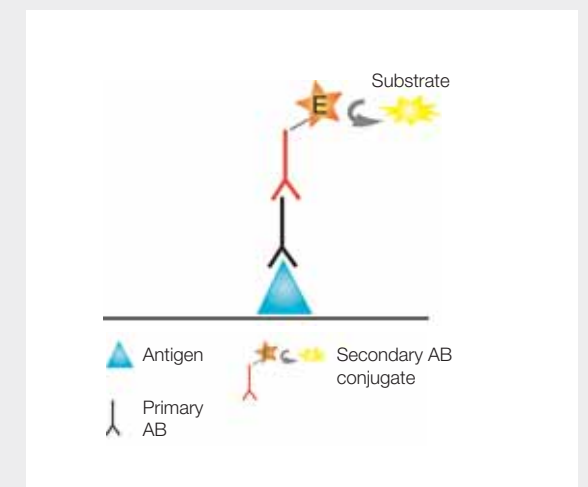

Figure 4B: Indirect ELISA

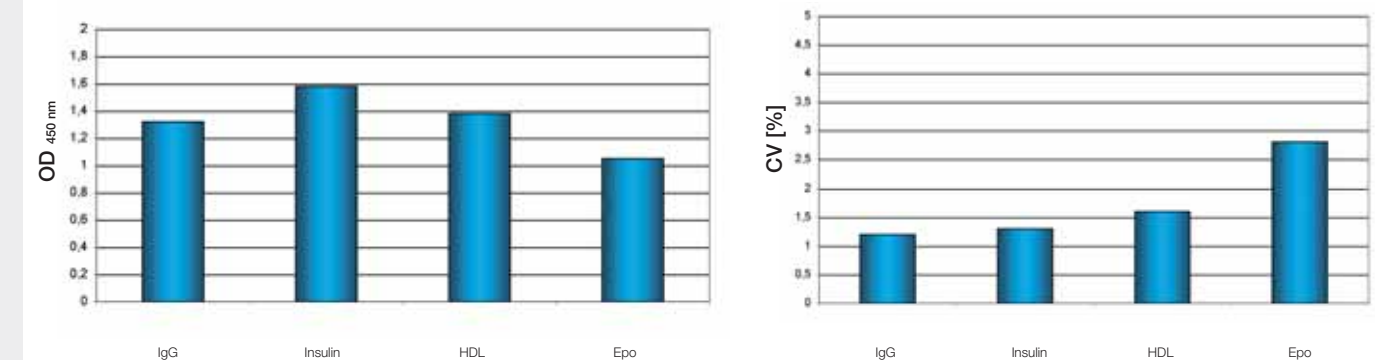

Figure 5: Optical density values and coefficients of variations for exemplary ELISAs established on Greiner Bio-One high binding microplates.

3.2. Binding of biotinylated proteins

Binding to a solid surface based upon passive adsorption is highly dependent on both the surface characteristics and the properties of the molecule to be bound (e.g. size, lot). Binding characteristics may vary between different molecules on the same solid surface. To illustrate this potential variability, four different biotinylated proteins were bound to a 96 well high binding plate and detected with a streptavidin-HRP conjugate (8 ng/ml). 0.05 M carbonate buffer, pH 9.6 was used as the coating buffer (Fig. 6A).

- Protein A is a 42 kDa surface receptor protein of the bacteria *Staphylococcus aureus*. It contains little or no carbohydrate, is devoid of cysteines and rich in aspartic and glutamic acids.
- Albumine (66 kDa, 584 AA) contains a lot of sulphureous amino acids.
- Glycoprotein IgG (human)
- Peptide hormone insulin

Binding curves for Protein A and IgG look very similar, whereas the curves for albumin and insulin

differ significantly (Fig. 6B). Taking into account the impact of molecule properties on binding, it is advisable to compare the performance of different surfaces when developing a new assay.

4. Microplate format and well profile

Microplates for ELISA applications are available in a large variety of formats: standard 96 well plates, strip plates and so-called single-break strip plates. The employment of strip plates or single-break plates offers the advantage of more flexibility. Individual strips or wells can be removed from the support frame so that the number of tests to be performed can be adjusted to the actual number of samples and is not predetermined by the microplate format used.

For some ELISA applications a reduction of the sample volumes can be an important aspect. Usually, this is done by moving from a 96 well microplate to a 384 well microplate. However, this implies significant changes in plate handling and the adaption of laboratory equipment. 96 well half area microplates offer an interesting alternative. This plate format allows a significant reduction of the sample volume within the accustomed 96 well plate format (Fig. 7, Table 3).

	96 well standard	96 well half area
Covered surface area	92 mm ²	82 mm ²
Corresponding liquid height	3 mm	4.7 mm
Volume coating solution	100 µL	75 µL
Washing Buffer	350 µL	150 µL
Anti human IgG-HRP conjugate	100 µL	75 µL
OD* 450 nm	1.2	1.3

* After adaption to 1 cm pathlength.

Table 3: Comparison standard – half area microplates

Different well profiles – U-, V-, F-, C-bottom – are available (Fig. 7,8,9). In general, immobilisation of biomolecules is not affected by the well profile. However, the fact that the covered surface area and the resulting area-to-volume ratio may vary should be taken into account (Table 4). F-bottom plates demonstrate excellent optical properties and are therefore ideal for precise optical measurements. They are additionally compatible with common microplate washers and readers.

U-bottom wells allow the removal of liquid without recess.

The C-bottom is a flat-bottom profile with rounded corners. It combines the excellent optical properties of the F-bottom profile with rounded well bottom edges, enabling liquid to be removed in entirety. Due to the round corners liquid can be removed entirely. V-bottom plates feature a conically tapered well bottom are ideally suited for applications in which the total sample volume must be pipetted off.

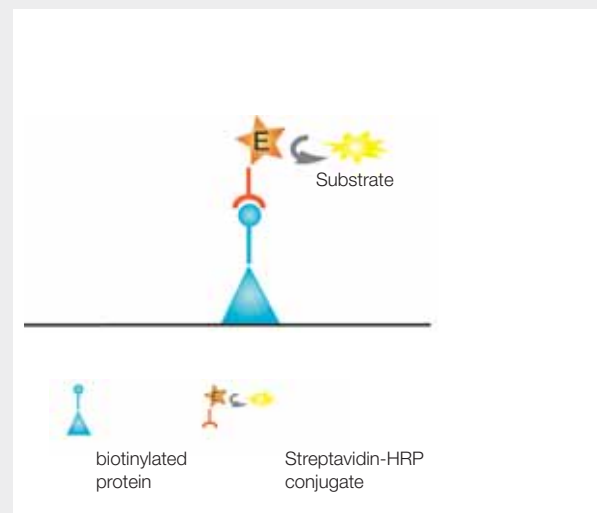

Figure 6A: Binding of biotinylated proteins and detection with streptavidin-HRP

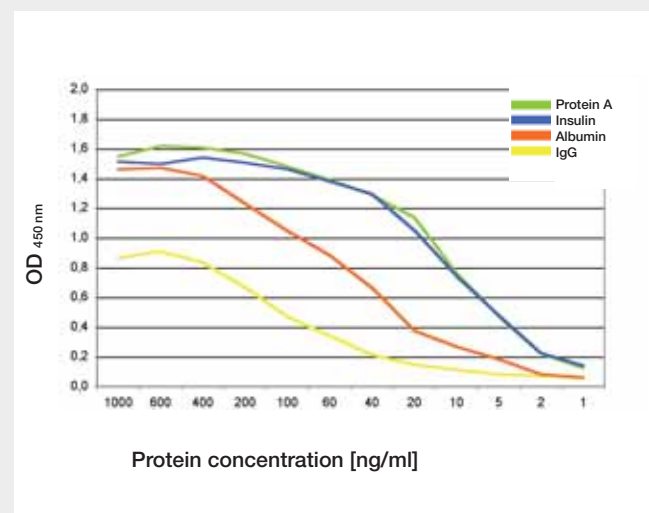

Figure 6B: Binding curves on a 96 well standard high binding microplate

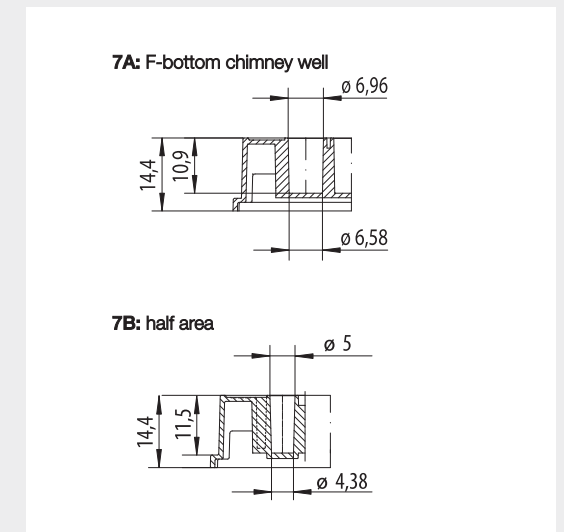

Figure 7: Well profiles 7A F-bottom/chimney well, 7B half area

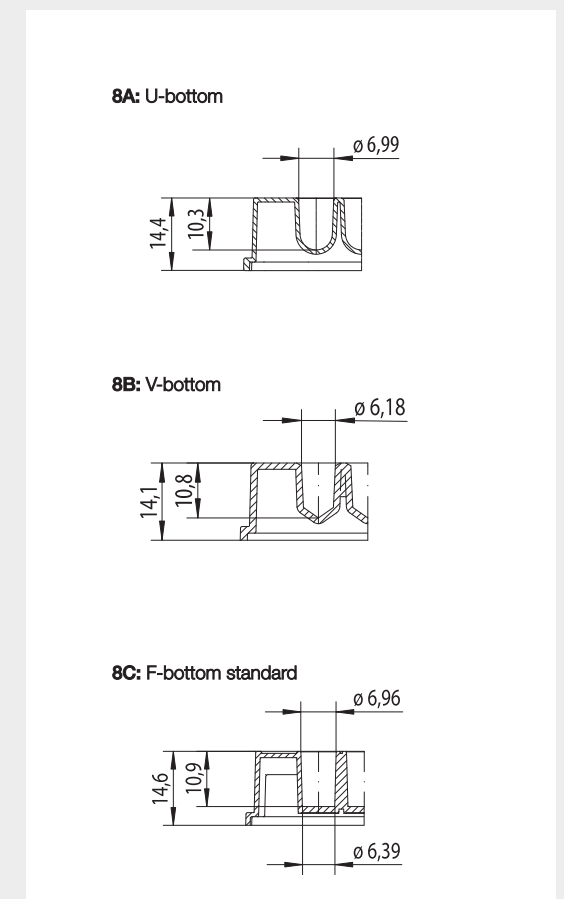
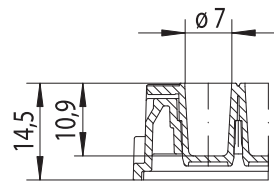
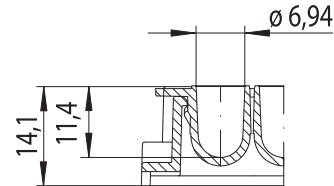

Figure 8: Different well profiles of 96 well ELISA microplates

9A: C-bottom single break strip plates: C8



9B: U-bottom strip plates: U8, U16



9C: F-bottom strip plates: F8, F12, F16

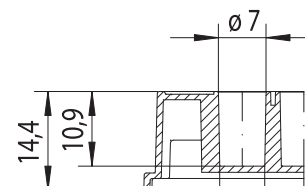

Figure 9: Different well profiles of 96 well ELISA strip plates

	Liquid volume (µl)	Covered surface area (mm ²)	Liquid height (mm)	Area / volume ratio (cm ² / cm ³)
96 well microplate U-bottom	100	84.6	4.2	8.5
96 well microplate V-bottom	100	88.6	5.3	8.9
96 well microplate F-bottom / standard	100	92	3.0	9.2
96 well microplate F-bottom / chimney well	100	93	2.9	9.3
96 well microplate F-bottom / half area	100	103.6	6.2	10.4
C8 Strip Plate	100	88.6	3.6	8.9
F8 Strip Plate	100	93.5	2.85	9.4
U8 Strip Plate	100	84	4.2	8.4
F12 Strip Plate	100	93.3	3.55	9.3
U16 Strip Plate	100	84	4.2	8.4
U16 Strip Plate	100	94.3	3.0	9.4

Table 4: Volume-dependent wetting of immunological plates

More detailed data are listed in the **technical appendix** of our catalogue or in the data sheets on our website:

www.huberlab.ch

5. Technical Appendix

Blocking

See **Buffer**

Buffer

Widely used assay buffers are PBS or Tris buffer. During the coating procedure ionic strength and pH of the buffer used can play an important role. The most common buffer for coating plastic surfaces with proteins and glycoproteins is 0.05 M carbonate buffer at pH 9.6. Nevertheless, for some proteins a different pH value may be more favourable. Alternative coating buffers are 10 mM PBS pH 7.4 or an acetate buffer at pH 5.5. It is essential to block unoccupied binding sites on the solid surface in a blocking step after coating to reduce non-specific binding and to avoid background problems during subsequent assay steps. Commonly used blocking agents are BSA, casein or non-fat dried milk powder in Tris or PBS buffer. Blocking buffers are commercially available as well. Washing steps are included into the assay protocol to remove unbound reagents after incubation steps. Insufficient washing may result in a high background, whereas excessive washing may lead to debonding of adsorbed assay components, thereby decreasing the sensitivity of the assay. Often the wash buffer is the same as used for

blocking to which detergent has been added. The detergent supports the removal of non-specifically bound molecules and subsequent minimisation of background. A commonly used detergent is Tween-20 in a concentration of 0.05%. The use of detergents should be avoided before blocking as this may cause a reverse effect and result in an increased background. Therefore, the most effective buffers to use for a given assay depend on the features of the assay components and the most suitable buffer system should be determined empirically. In general, phosphate buffer interferes with alkaline phosphatase (see **Detection**).

Capture ELISA

See **Sandwich ELISA**

Checkerboard titration (Fig. A)

When developing an ELISA optimal working concentrations for all assay components must be determined empirically. This is done by performing a so-called checkerboard titration. In such an experiment the concentration of two assay components is systematically varied. From the resulting data a combination of concentrations of the tested substances can be chosen that results in optimal optical density values and ensures a consistent performance of the ELISA.

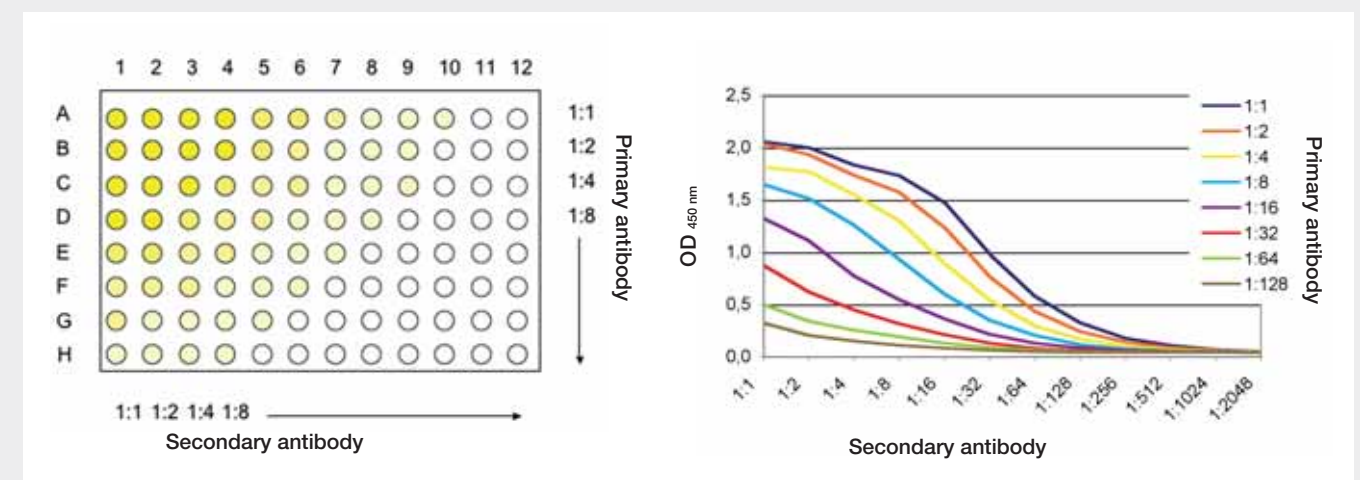

Figure A: Checkerboard titration

Competitive ELISA (Fig. B)

In a competitive ELISA a labelled and pretitrated assay component is added simultaneously with the sample. If the antigen is bound to the solid surface then a mixture of sample and the labelled antibody is added in the incubation step. The antibodies contained in the sample and the enzyme-labelled antibodies compete for antigen binding. The more antibodies contained in the sample, the less enzyme-labelled antibody is available to bind to the antigen coating. The reduced binding of the labeled antibody results in a decrease of the signal. Alternatively the antibody can be bound to the surface, after which the labelled antigen is added to compete with antigen contained in the sample during the immunological reaction.

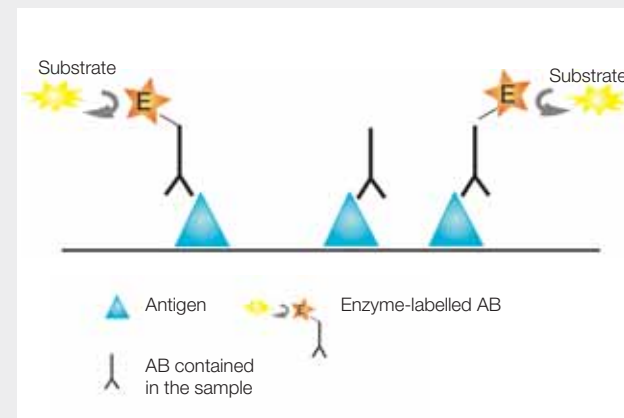

Figure B: Competitive ELISA

Detection

Initially, the detection of the interaction between antigen and antibody was based on radioisotope labelling. Today, enzymes, biotin or fluorophores are widely used for labelling and detection is based on chromogenic, fluorescent or chemoluminescent substrates. The intensity of the released signal is correlated with the amount of analyte in the sample. These detection methods are equally or even more sensitive than the radiochemical approach but are free of the problems

due to working with radioactive material. The two most commonly used enzyme labels are horseradish peroxidase (HRP) and alkaline phosphatase (AP). Suitable substrates are commercially available for both enzymes.

Colorimetric detection results in a coloured reaction product which can be quantified with a spectrophotometer. Widely used chromogenic substrates are 3, 3', 5, 5'-tetramethylbenzidine (TMB) for HRP and p-nitrophenyl phosphate (pNPP) for AP. For colorimetric detection clear microplates are ideal.

Black microplates and strips are used for fluorescent immunoassays (FIA) as black microplates reduce background autofluorescence, well-to-well cross talk and light scattering. Fluorescence is a physical process where molecules (e.g. a fluorescent substrate) are excited by the absorption of light of a certain wavelength. When the molecules return to their ground state they emit light at a different wavelength. A fluorometer is needed to view the results. Luminescent immunoassays (LIA) are very sensitive as the signal can be multiplied and amplified. In luminescent immunoassays an enzyme catalyses the conversion of a substrate to a product that emits light. White plates and strips are ideal for luminescence detection as the white wells enhance the signal by reflecting the light. Cross talk and background luminescence are minimised. The emitted light is measured by a luminometer.

Direct and indirect ELISA (Fig. C, D)

Assays can be divided into "direct" and "indirect" methods. In a direct ELISA the assay component bound to the solid surface interacts with the enzyme-labelled second assay component. Direct ELISAs are not widely used as labelling of the antigen or the primary antibody is time-consuming and expensive.

In an indirect ELISA detection is conducted with an enzyme-labelled secondary antibody. First, a primary antibody interacts with the antigen. In a second

incubation step a labelled secondary antibody that recognises the primary antibody is used. If primary antibodies from the same species are used in different assays, the same enzyme-labelled secondary antibody can be used for detection. Additionally, sensitivity is increased as several secondary antibodies can bind to one primary antibody resulting in signal amplification. Labelled secondary antibodies are commercially available in a large variety.

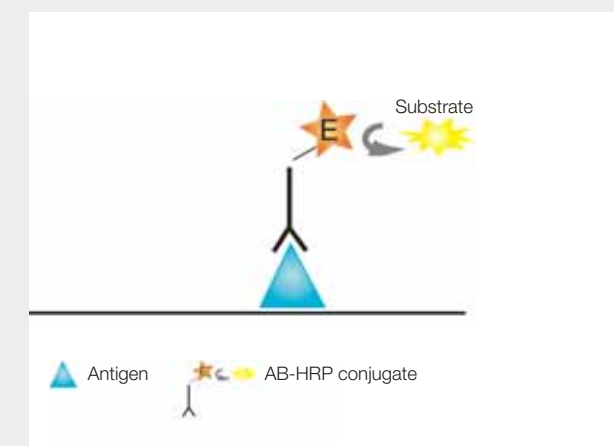

Figure C: Direct ELISA

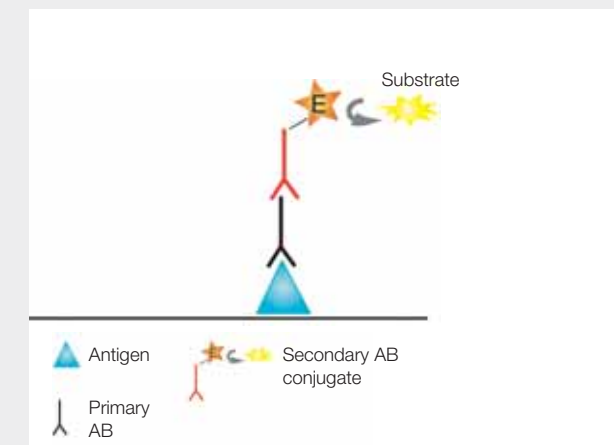

Figure D: Indirect ELISA

Sandwich ELISA (Fig. E)

Sandwich ELISA is used when antigens can not be bound directly to the solid surface. Instead the solid surface is coated with a specific antibody which is used to "capture" the antigen. Therefore, sandwich ELISA is sometimes referred to as capture ELISA. In a second immunological reaction, a second specific antibody is added which is detected by an enzyme-labelled secondary antibody. As a result, the antigen is bound between two antibodies. For sandwich ELISA an antigen must contain at least two epitopes which allow the parallel binding of two antibodies.

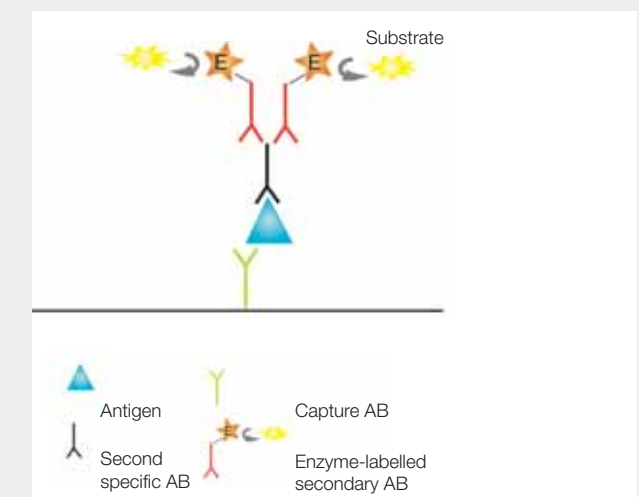

Figure E: Sandwich ELISA

Temperature

Temperature influences the timeframe for binding of molecules to the solid surface. Total will be the same after a certain point, however, the rate of binding depends on the chosen incubation temperature. An increased incubation temperature allows the reduction of the incubation time. Typical incubation temperatures for coating are 4°C, 22°C and 37°C. Note that the enzyme-substrate reaction is also temperature-sensitive. A temperature gradient within the plate during detection may result in a shift of OD values between outer wells and center wells (edge-effect). Therefore a temperature gradient should be avoided.

Typical protocol for an indirect ELISA (Fig. F)

The test protocol below describes an indirect ELISA in a 96 well polystyrene high binding microplate which is based upon the adsorptive binding of insulin to the inner surface of the wells and the subsequent interaction of the bound insulin with a specific monoclonal anti-insulin antibody produced in mouse. For detection an anti-mouse IgG-HRP conjugate is used.

1. Coating

The wells are filled with 100 µl coating solution (800 ng/ml insulin in 0.05 M carbonate buffer; pH 9.6) and stored in an incubator overnight (about 18 h) at 23°C. To avoid evaporation, a petri dish can be filled with water and placed in the incubator. Alternatively, the plates can be sealed with plate sealers.

2. Washing

After incubation the plates are washed four times with 350 µl PBS-T buffer (0.14 M NaCl; 0.01 M PO₄; 0.05% Tween 20; pH 7.4) per well. After the last washing step any remaining liquid has to be removed by tapping the plate onto a paper towel.

3. Blocking

Unoccupied binding sites on the well surface are blocked with BSA in order to avoid binding of antibodies in subsequent steps of the assay. The plates are filled with 150 µl/well blocking solution (3% BSA in PBS-T) and incubated for 60 min. at 23°C. After incubation, the solution is hand-decanted. Remaining liquid is removed by rapping the plate onto a paper towel.

4. Addition of primary antibody

During the immunochemical reaction, the anti-insulin antibody (primary antibody) is added and binds to the affixed insulin molecules. The plates are filled with 100 µl/well of primary antibody solution (80 ng/ml monoclonal mouse anti-insulin antibody in PBS-T) and incubated at 23°C for 60 min.

5. Washing

Unbound antibodies are washed away in a subsequent washing procedure (see 2).

6. Addition of secondary antibody

For detection of the interaction between insulin and the specific antibody an anti-mouse IgG-HRP conjugate (secondary antibody) is used. The plates are filled with 100 µl/well of secondary antibody solution (300 ng/ml anti-mouse IgG antibody-HRP conjugate in PBS-T). The plates are incubated at 23°C for 60 min.

7. Washing

See 2.

8. Detection

The plates are filled with 100 µl/well substrate solution (1 part of TMB to three parts of citric acid/acetate, each 0.1M; pH 4.9) and incubated at 23°C for 20 min. TMB is split by HRP and a coloured substance is released. The colorimetric reaction is stopped and fixed by adding 100 µl 0.5 M sulphuric acid per well. The strength of the colour reaction is measured by a microplate reader at 450 nm. As the reaction is stable for a maximum of 1 hour, the plates should be measured within this timeframe.

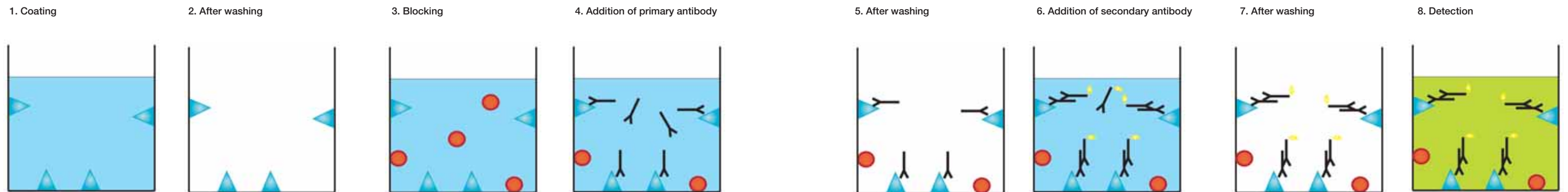

Figure F: Typical protocol for an indirect ELISA

6. Ordering Information

Cat.-No.	Description	Qty./ bag	Qty./ case
650 001	Microplate, 96 well, PS, U-bottom, MICROLON® 200, med. binding, clear	5	40
650 061	Microplate, 96 well, PS, U-bottom, MICROLON® 600, high binding, clear	5	40
651 001	Microplate, 96 well, PS, V-bottom, MICROLON® 200, med. binding, clear	5	40
651 061	Microplate, 96 well, PS, V-bottom, MICROLON® 600, high binding, clear	5	40
655 001	Microplate, 96 well, PS, F-bottom/standard, MICROLON® 200, med. binding, clear	5	40
655 061	Microplate, 96 well, PS, F-bottom/standard, MICROLON® 600, high binding, clear	5	40
655 075	Microplate, 96 well, PS, F-bottom/chimney well, LUMITRAC™ 200, med. binding, white	5	40
655 074	Microplate, 96 well, PS, F-bottom/chimney well, LUMITRAC™ 600, high binding, white	5	40
655 076	Microplate, 96 well, PS, F-bottom/chimney well, FLUOTRAC™ 200, med. binding, black	5	40
655 077	Microplate, 96 well, PS, F-bottom/chimney well, FLUOTRAC™ 600, high binding, black	5	40
655 080	Microplate, 96 well, PS, F-bottom/chimney well, MICROLON® 200, med. binding, clear	5	40
655 081	Microplate, 96 well, PS, F-bottom/chimney well, MICROLON® 600, high binding, clear	5	40
655 095	Microplate, 96 well, PS, F-bottom/chimney well, µClear®, med. binding, white	10	40
655 094	Microplate, 96 well, PS, F-bottom/chimney well, µClear®, high binding, white	10	40
655 096	Microplate, 96 well, PS, F-bottom/chimney well, µClear®, med. binding, black	10	40
655 097	Microplate, 96 well, PS, F-bottom/chimney well, µClear®, high binding, black	10	40
675 001	Microplate, 96 well, PS, half-area, MICROLON® 200, med. binding, clear	10	40

Cat.-No.	Description	Qty./ bag	Qty./ case
675 061	Microplate, 96 well, PS, half area, MICROLON® 600, high binding, clear	10	40
675 075	Microplate, 96 well, PS, half area, med. binding, white	10	40
675 074	Microplate, 96 well, PS, half area, high binding, white	10	40
675 076	Microplate, 96 well, PS, half area, med. binding, black	10	40
675 077	Microplate, 96 well, PS, half area, high binding, black	10	40
675 095	Microplate, 96 well, PS, half area, µClear®, med. binding, white	10	40
675 094	Microplate, 96 well, PS, half area, µClear®, high binding, white	10	40
675 096	Microplate, 96 well, PS, half area, µClear®, med. binding, black	10	40
675 097	Microplate, 96 well, PS, half area, µClear®, high binding, black	10	40
701 070	96 well strip plate, 8 x F12 strips, F-bottom, MICROLON® 200, med. binding, clear	5	100
701 071	96 well strip plate, 8 x F12 strips, F-bottom, MICROLON® 600, high binding, clear	5	100
754 070	96 well strip plate, 6 x U16 strips, U-bottom, MICROLON® 200, med. binding, clear	5	100
754 061	96 well strip plate, 6 x U16 strips, U-bottom, MICROLON® 600, high binding, clear	5	100
756 070	96 well strip plate, 6 x F16 strips, F-bottom, MICROLON® 200, med. binding, clear	5	100
756 071	96 well strip plate, 6 x F16 strips, F-bottom, MICROLON® 600, high binding, clear	5	100
762 070	96 well strip plate, 12 x F8 strips, F-bottom, MICROLON® 200, med. binding, clear	5	100
762 071	96 well strip plate, 12 x F8 strips, F-bottom, MICROLON® 600, high binding, clear	5	100

Cat.-No.	Description	Qty./ bag	Qty./ case
762 075	96 well strip plate, 12 x F8 strips, F-bottom, LUMITRAC™ 200, med. binding, white	5	100
762 074	96 well strip plate, 12 x F8 strips, F-bottom, LUMITRAC™ 600, high binding, white	5	100
762 076	96 well strip plate, 12 x F8 strips, F-bottom, FLUOTRAC™ 200, med. binding, black	5	100
762 077	96 well strip plate, 12 x F8 strips, F-bottom, FLUOTRAC™ 600, high binding, black	5	100
767 070	96 well strip plate, 12 x U8 strips, U-bottom, MICROLON® 200, med. binding, clear	5	100
767 071	96 well strip plate, 12 x U8 strips, U-bottom, MICROLON® 600, high binding, clear	5	100
705 070	Single-break strip plate, 12 x C8 strips, PS, C-bottom, MICROLON® 200, med. binding, clear	5	100
705 071	Single-break strip plate, 12 x C8 strips, PS, C-bottom, MICROLON® 600, high binding, clear	5	100
705 063	Single-break strip plate, 12 x C8 strips, PS, C-bottom, MICROLON® 200, med. binding, clear, red colour coding	5	100
705 073	Single-break strip plate, 12 x C8 strips, PS, C-bottom, MICROLON® 600, high binding, clear, red colour coding	5	100
705 064	Single-break strip plate, 12 x C8 strips, PS, C-bottom, MICROLON® 200, med. binding, clear, blue colour coding	5	100
705 074	Single-break strip plate, 12 x C8 strips, PS, C-bottom, MICROLON® 600, high binding, clear, blue colour coding	5	100
705 065	Single-break strip plate, 12 x C8 strips, PS, C-bottom, MICROLON® 200, med. binding, clear, green colour coding	5	100
705 075	Single-break strip plate, 12 x C8 strips, PS, C-bottom, MICROLON® 600, high binding, clear, green colour coding	5	100
705 066	Single-break strip plate, 12 x C8 strips, PS, C-bottom, MICROLON® 200, med. binding, clear, yellow colour coding	5	100
705 076	Single-break strip plate, 12 x C8 strips, PS, C-bottom, MICROLON® 600, high binding, clear, yellow colour coding	5	100